

**SCHLUMBERGER**

SCHLUMBERGER OF CANADA Calgary, Alberta

**TEMPERATURE LOG**

COMPANY IMPERIAL OIL ENTERPRISES LTD.

WELL 10E SPRING RIVER YT

FIELD

PROVINCE YUKON TERRITORIES

LOCATION

69° 07' 53" N LAT  
138° 44' 05" W LONG

Other Services:  
SLC, GR, FDC, DIL  
ICS, HDT, MCS

Permanent Datum KB 14 Elev 304  
Log Measured From \_\_\_\_\_ Ft Above Perm. Datum

ELEV KB 318  
GL 304  
CBF \_\_\_\_\_

PROVINCE YUKON TERRITORIES  
FIELD 10E SPRING RIVER YT  
WELL N-58  
COMPANY IMPERIAL OIL ENTERPRISES LTD.

Date	15 MAR 71	Bit Size - Inches	9 1/2"
Run No.	ONE	Csg. Size - Inches	10 3/4" to 1978
First Reading	3000	Csg. Wt. - Pounds	to to
Last Reading	50	Tubing Size - Inches	to to
Feet Measured	STATIONARY MEASUREMENTS	8 HRS	
Bottom Driller	7009	Op. Rig Time	OSU-C 363 REM
Depth Reached	6438	Truck No.	NICKERSON
Fluid Type	GEL MUD	Recorded By	KAP JACK & STAPLES
Fluid Level	FULL	Witness	
Fluid Res.	1.97 @ 89 °F		

Perforated Interval	to to	Production Fluid	
Injection Fluid		Pressure	
Temp.		Temp.	
Rate		Rate	

Cementation Date	Date	Time Started	Time Stopped
Circulation Date	Date	Time Started	Time Stopped
Cement	Quantity	Type	Additives
Calculated Top			
Plug Depth	Date		
Pressure Released	Date		
Drilling Stopped	Date	Time	1900
Csg. Shoe	Depth		1978

1 of

6 APR 71 CAL EMP

REMARKS

Drilling Stopped 1900 / 13th : Circulation Stopped 1900 / 13th : Tool on Bottom 1040 / 16th : 1st Run Service Order # 5697 B.H.T. 115 °F

TEMPERATURE RECORDED BY MAXIMUM READING THERMOMETER 1045 / 16.

Cartridge No.	A 36
Sonde No.	B 796
Panel No.	B 789 E

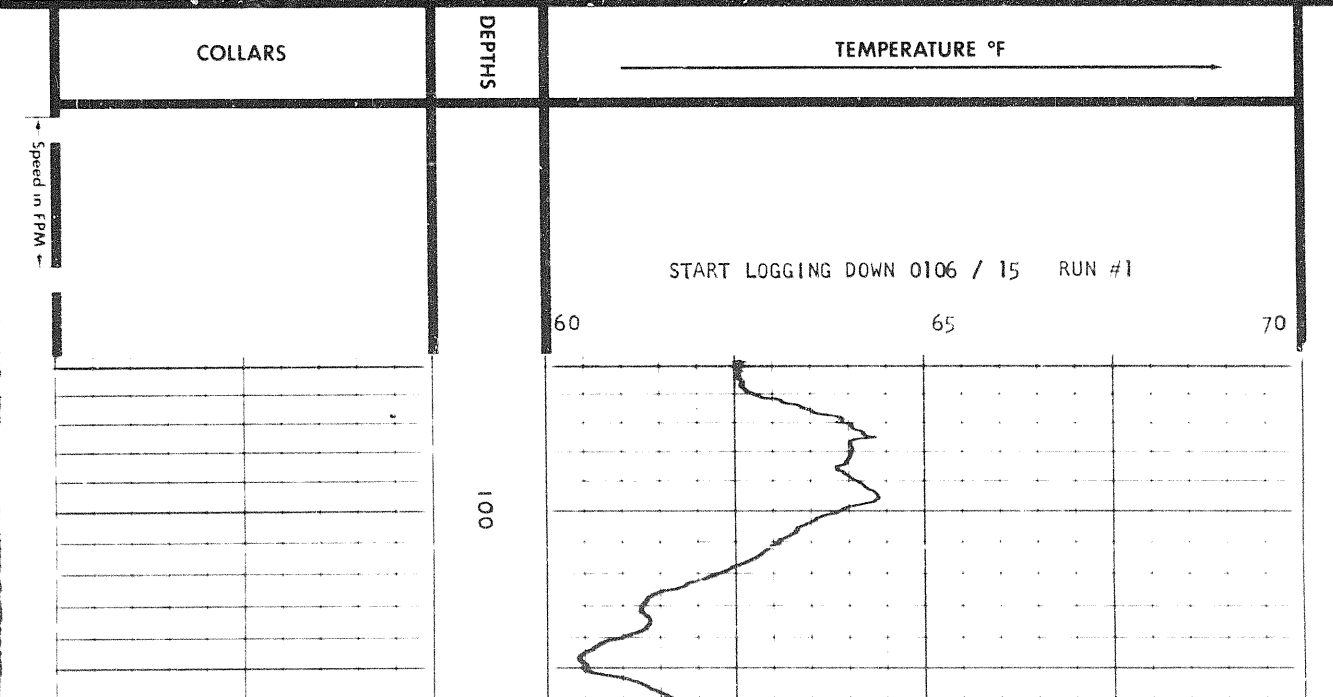

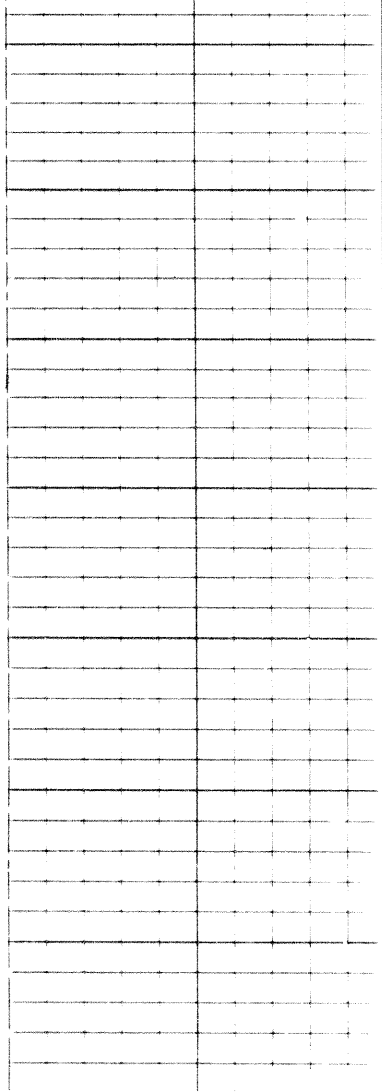

200

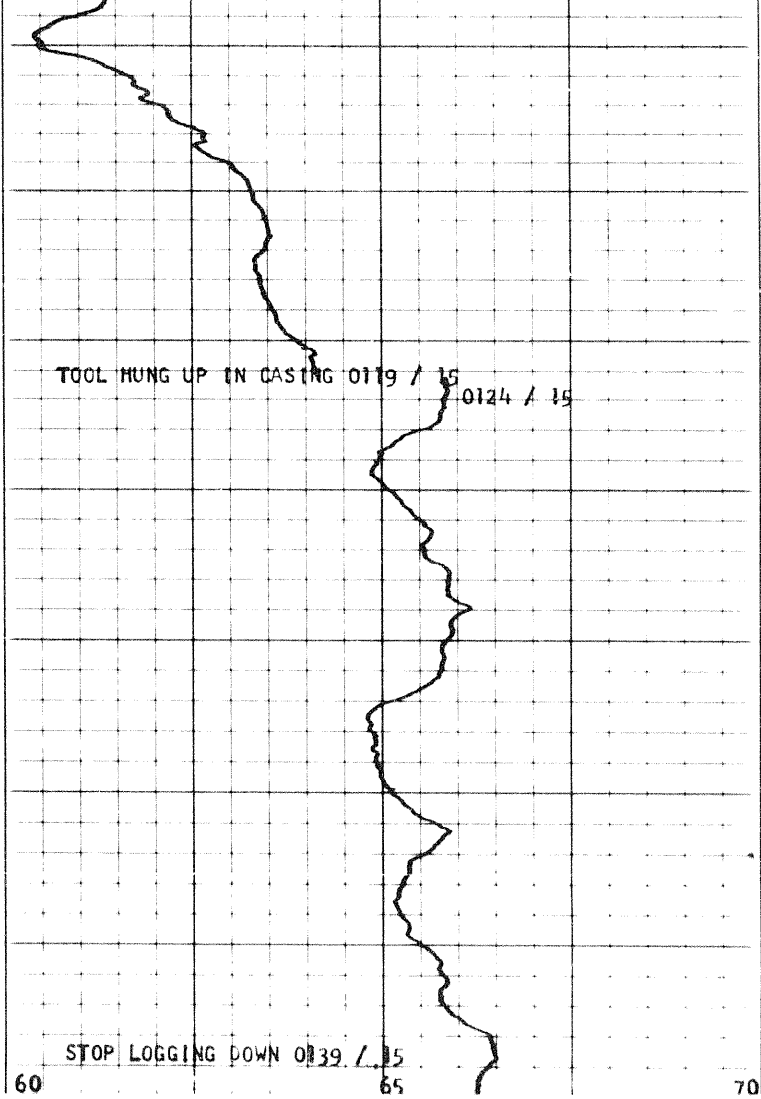

300

400

50

60

65

70

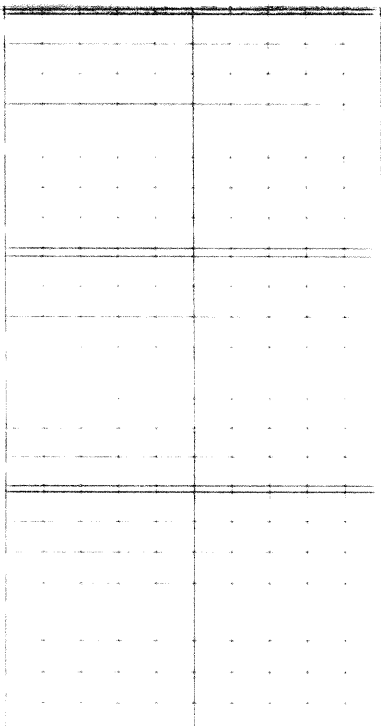

1000

60

65

70

1500

70

75

80

2000

70

75

80

STATIONARY READINGS.

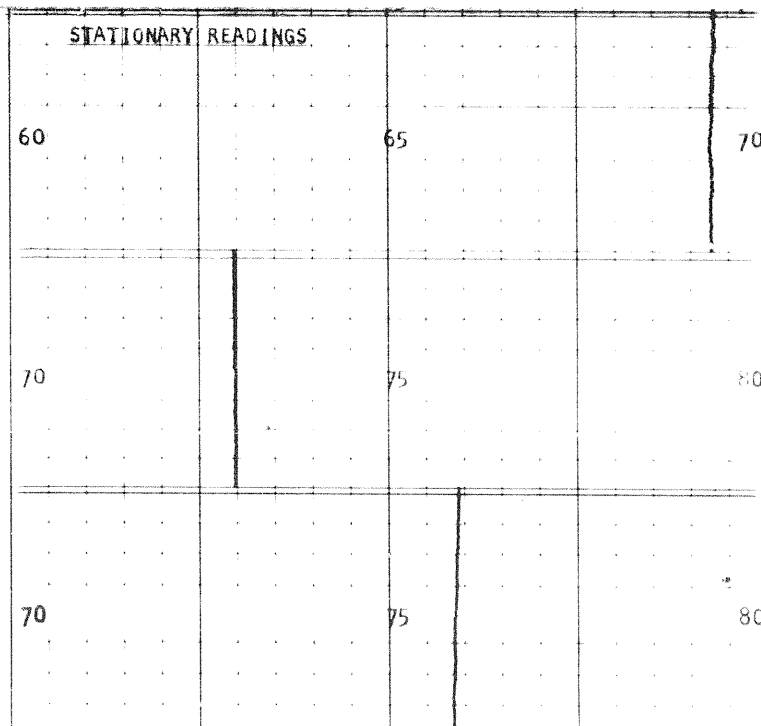

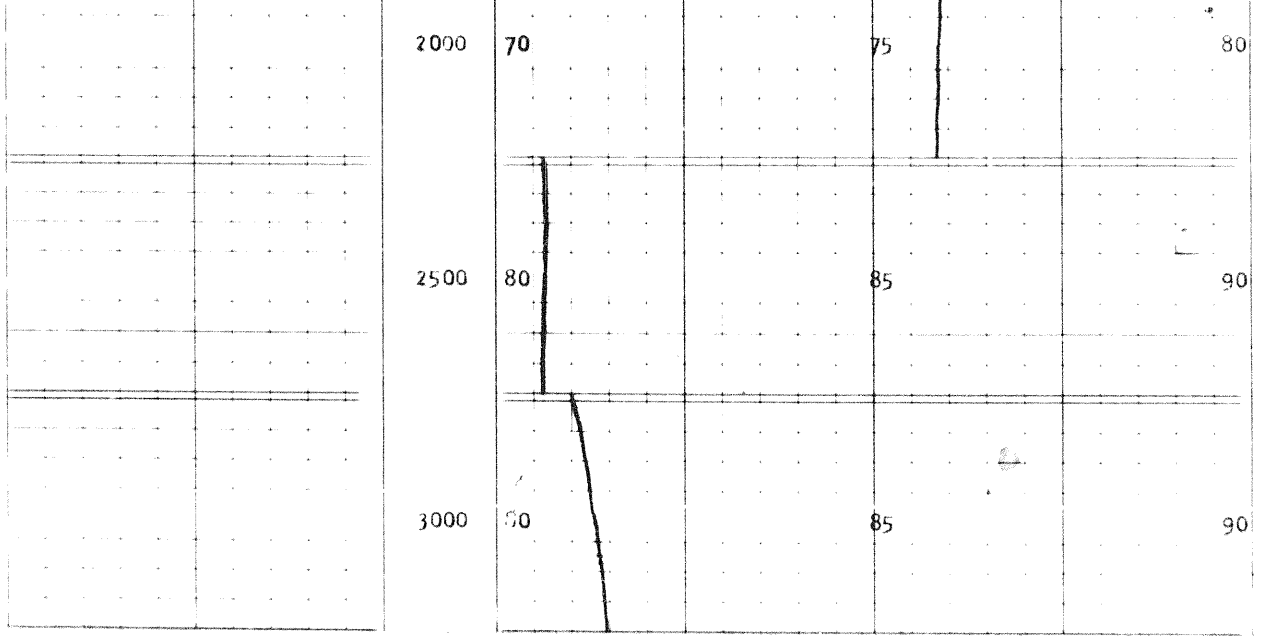

START LOGGING DOWN 0814 / 16 RUN #2  
FIRST READING 6435

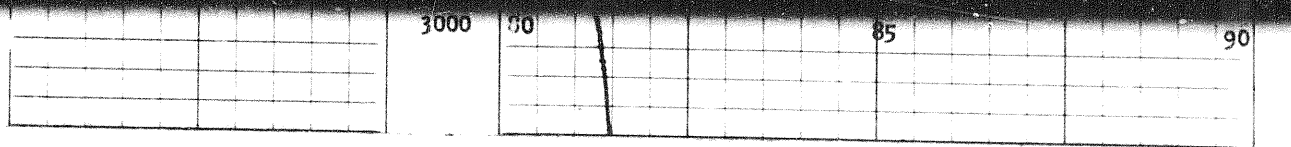
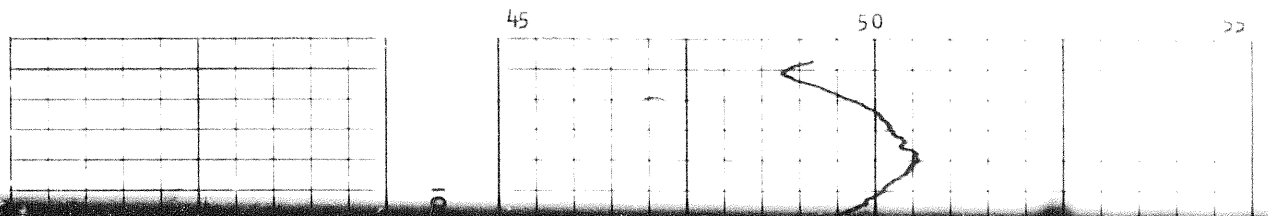

START LOGGING DOWN 0814 / 16 RUN #2  
FIRST READING 6435

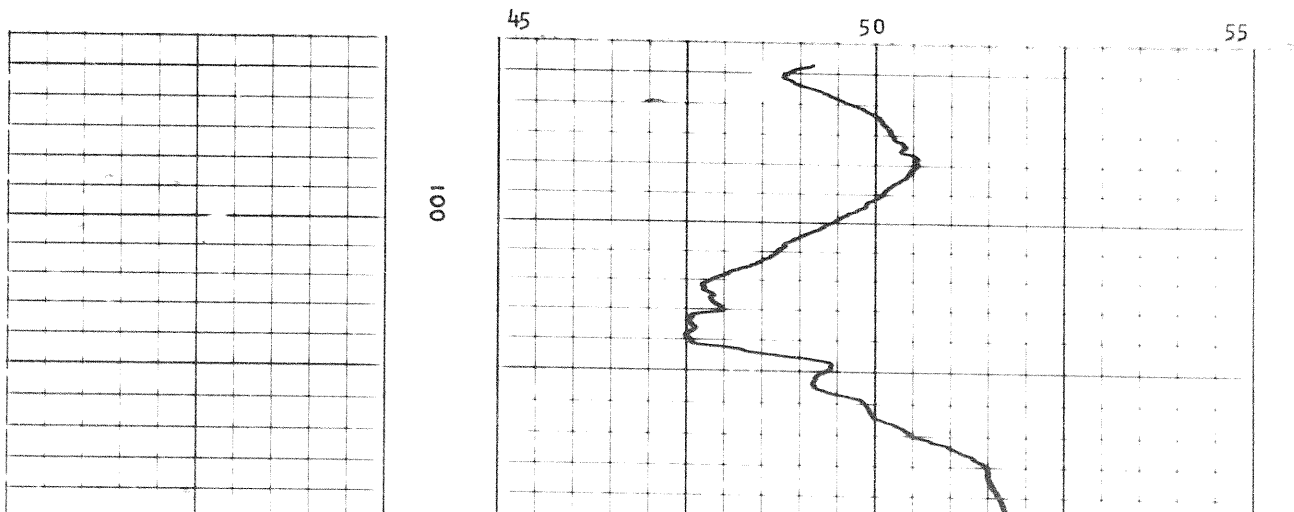

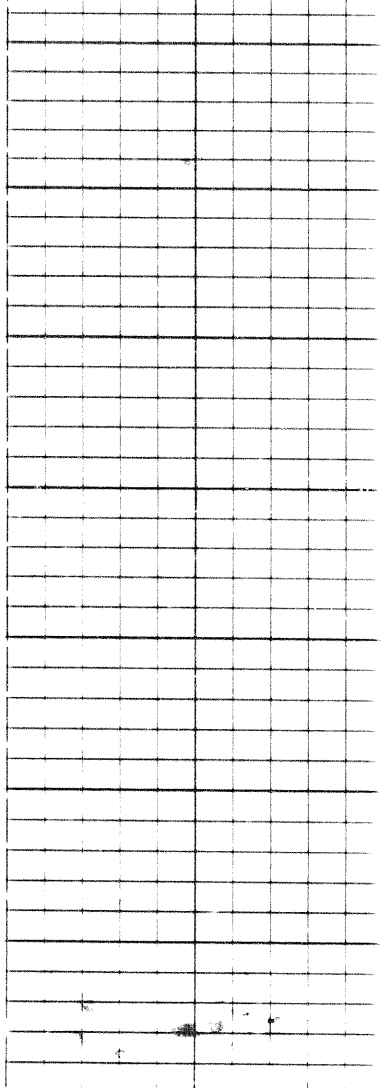

200

300

400

500

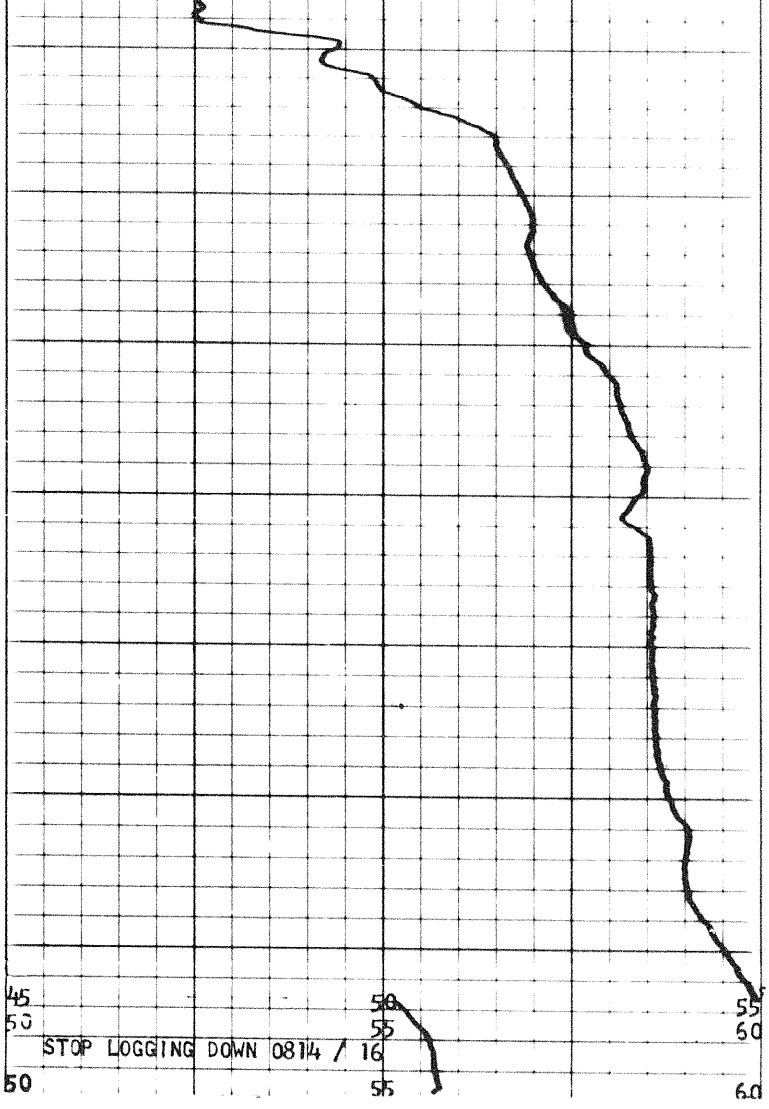

45

50

55

58

55

55

55

60

60

202

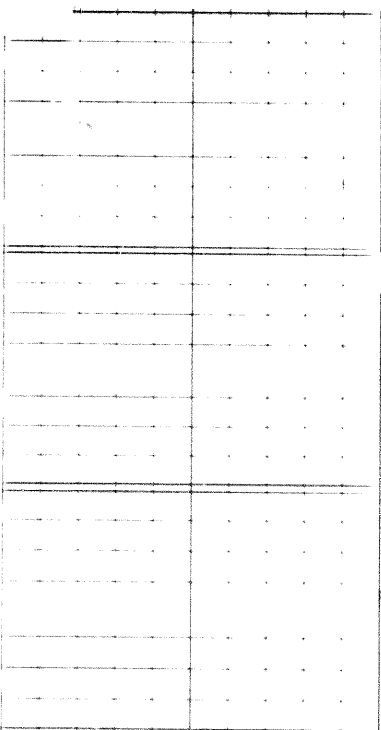

1000

1500

2000

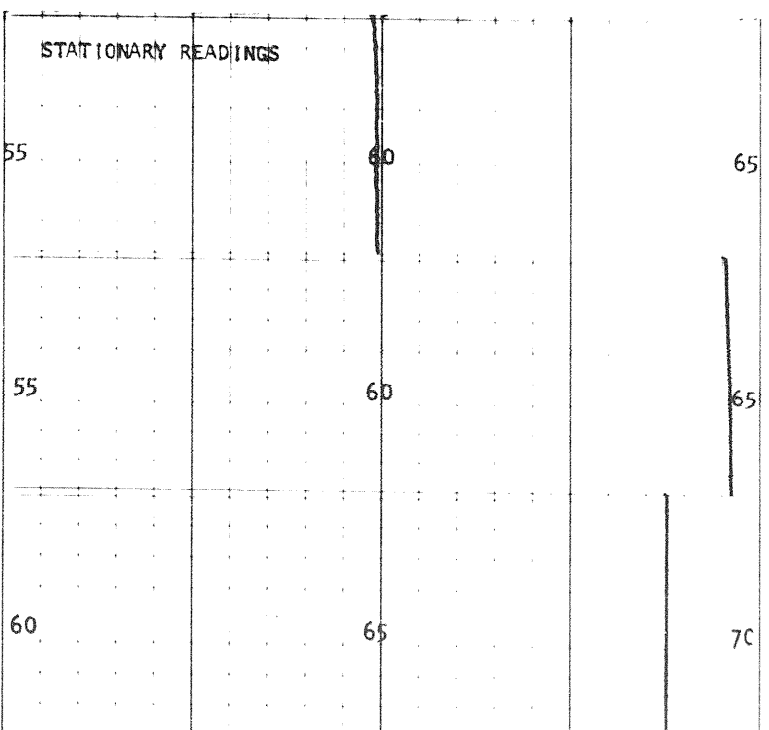

55

55

60

60

60

65

65

65

70



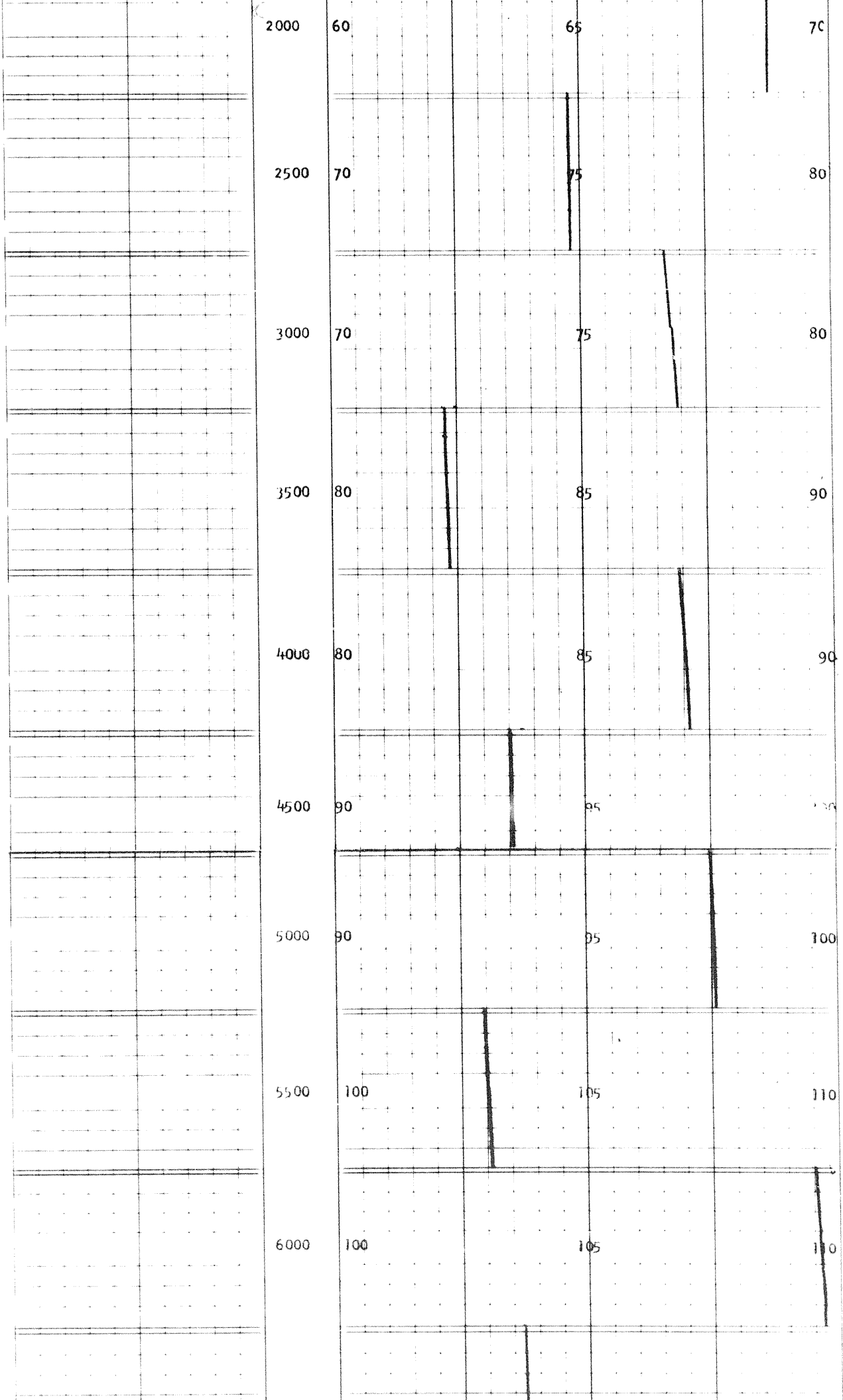

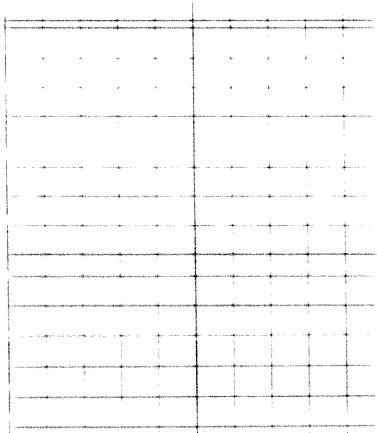

6250

110

115

120

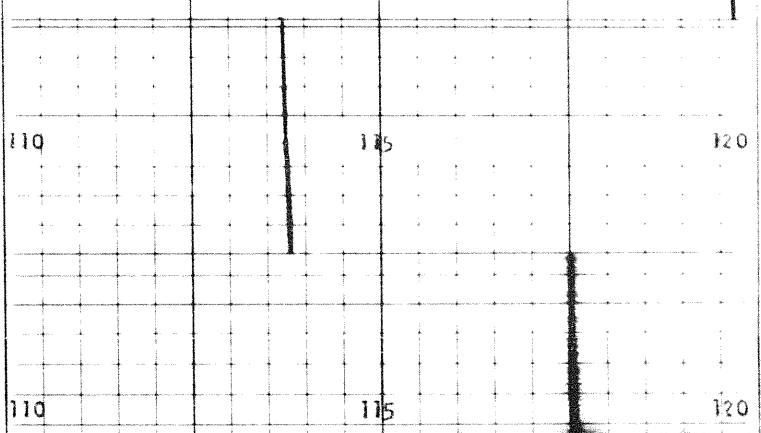

6435

110

115

120

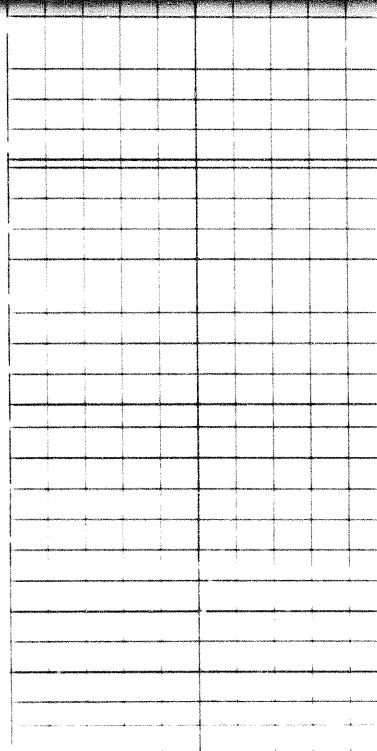

6000

100

105

110

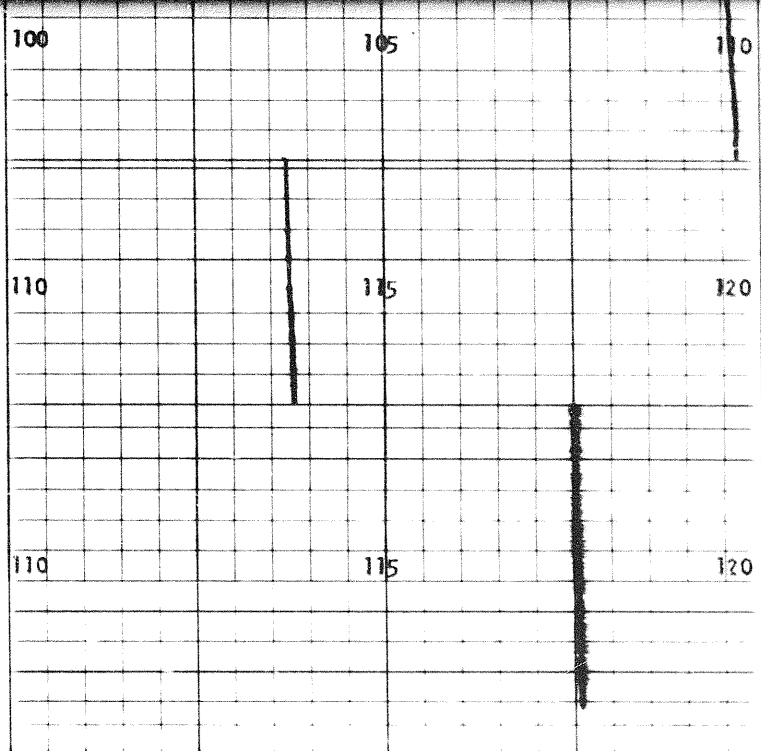

6250

110

115

120

6435

110

115

120

3 of 4

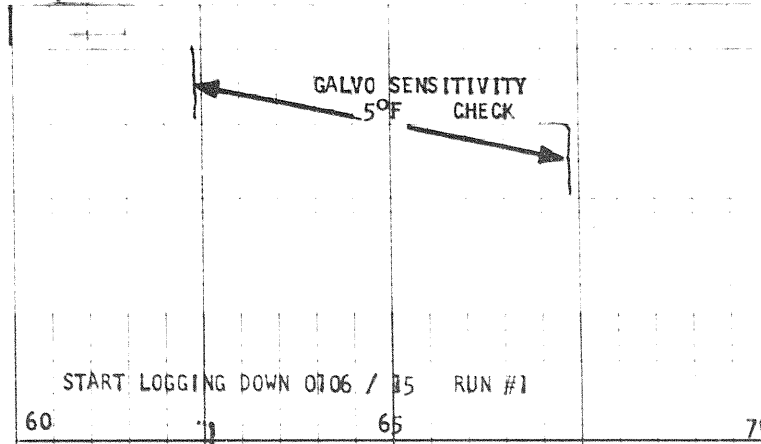

GALVO SENSITIVITY  
5°F CHECK

START LOGGING DOWN 0706 / 15 RUN #1

60

65

70

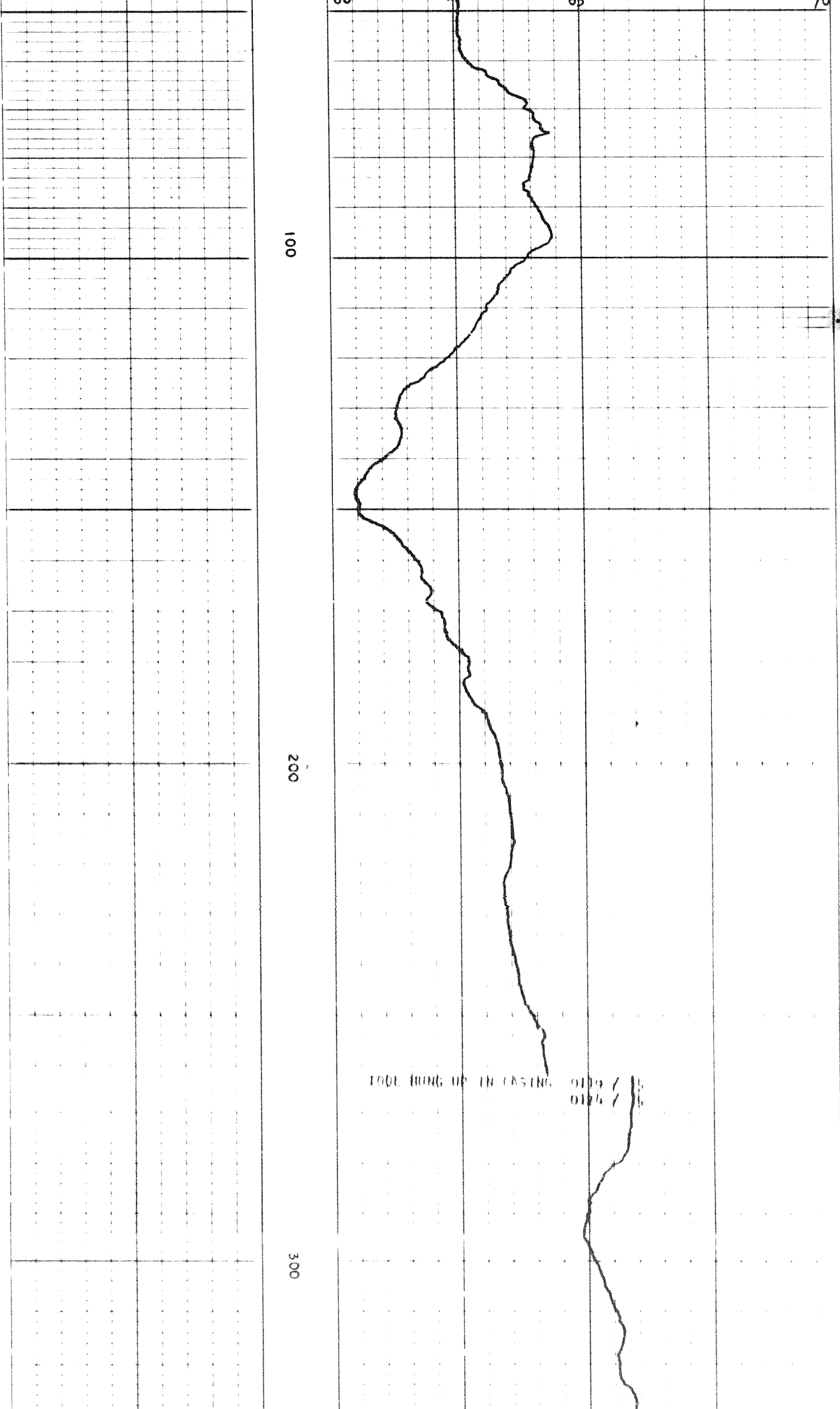

100

200

300

TUBE HUNG UP IN CASING 9109 / 10  
0124 / 10

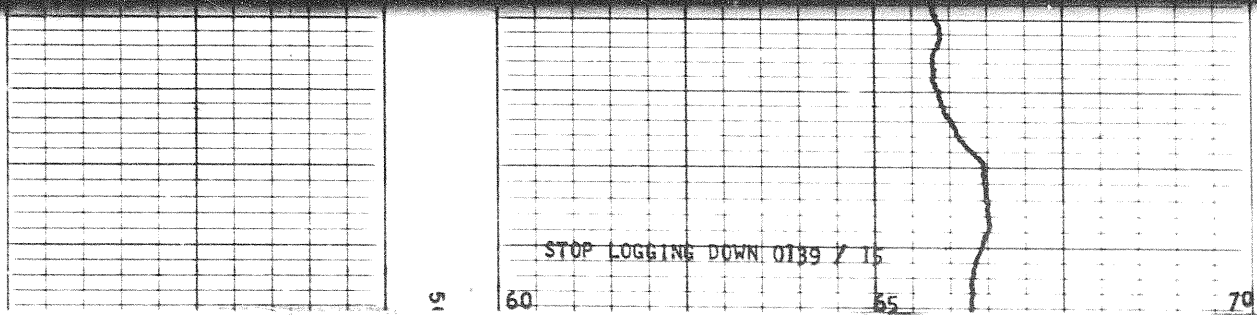
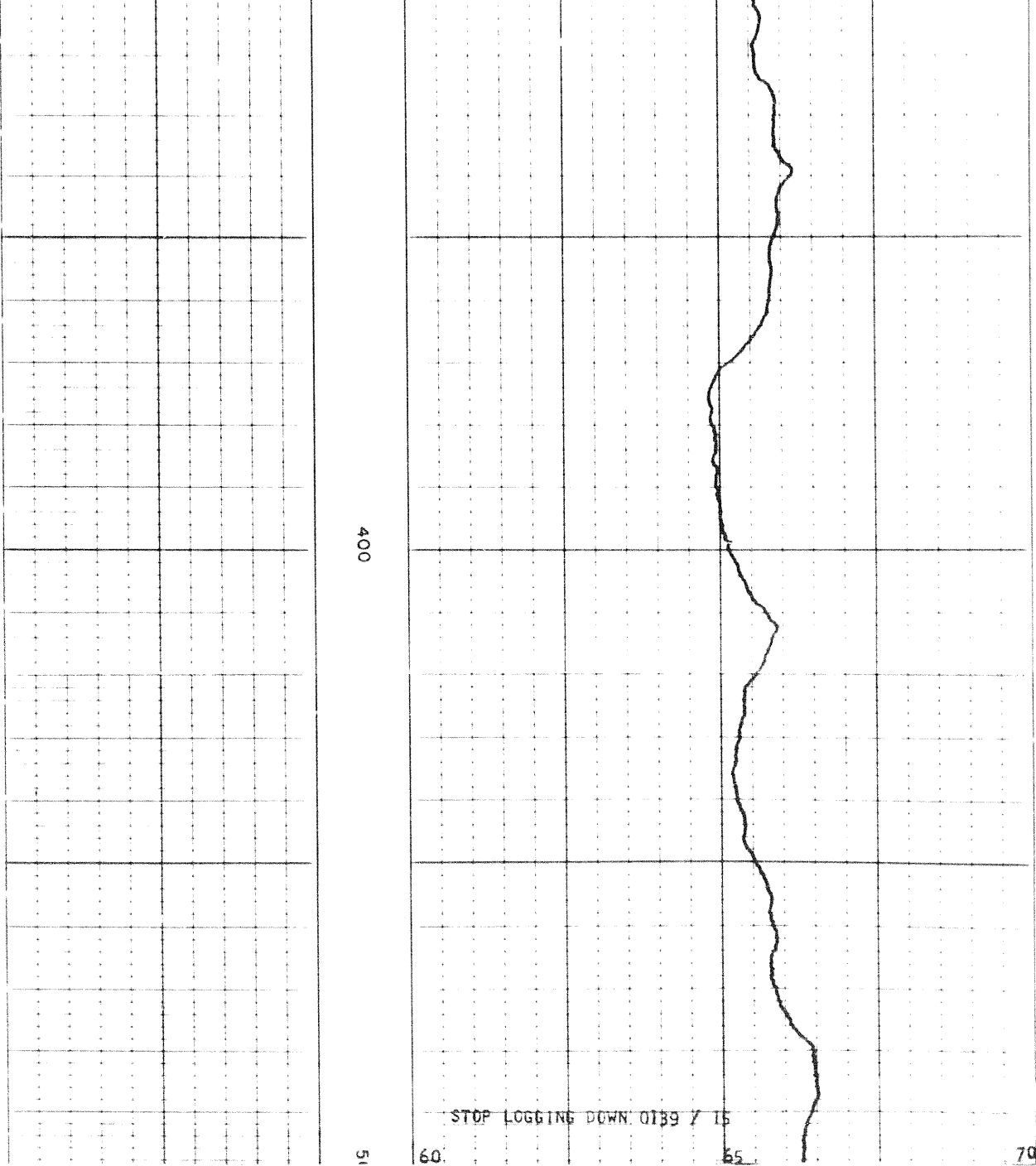



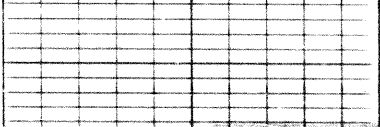

STOP LOGGING DOWN 0139 / 15

59 60 65 70

11-07

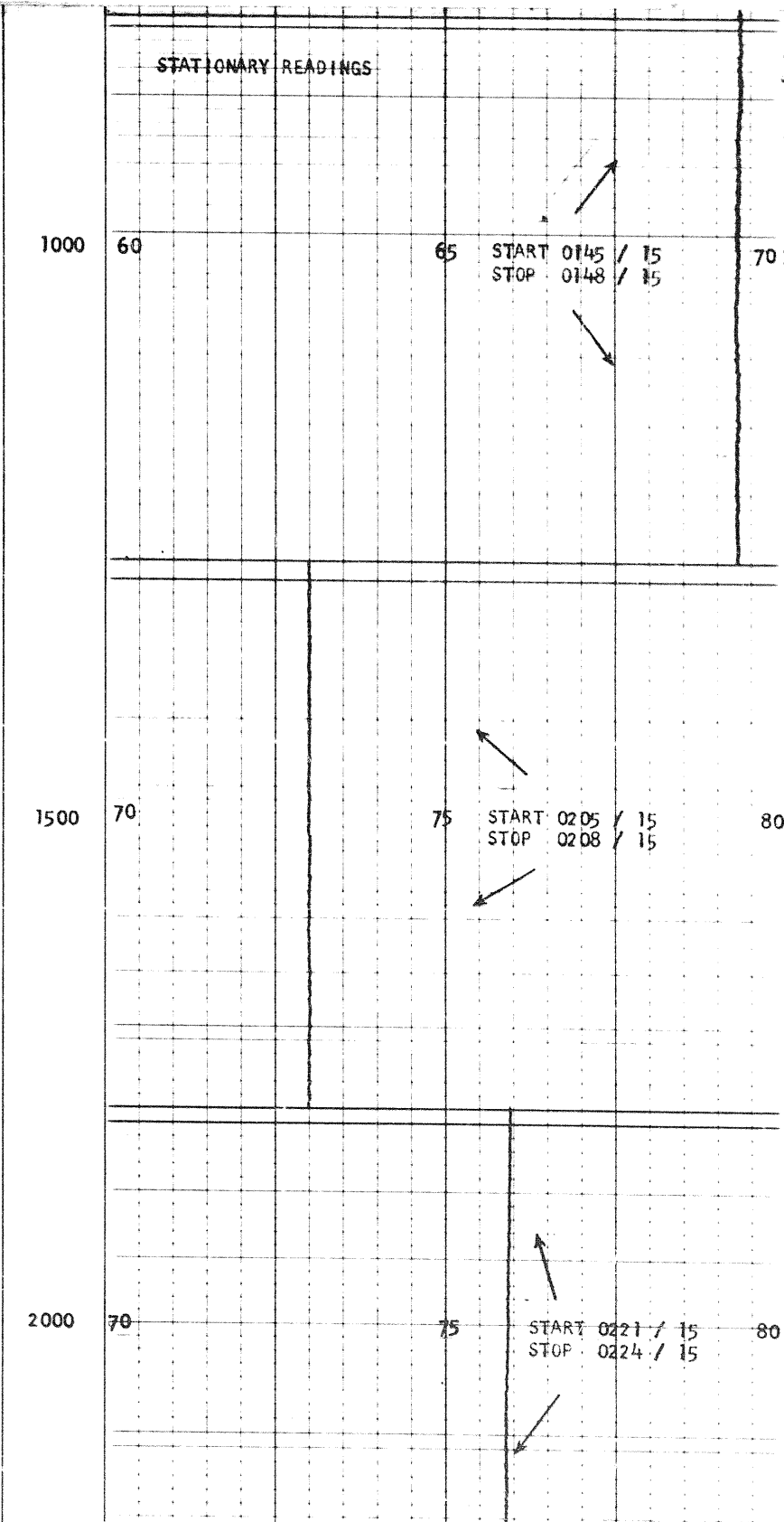
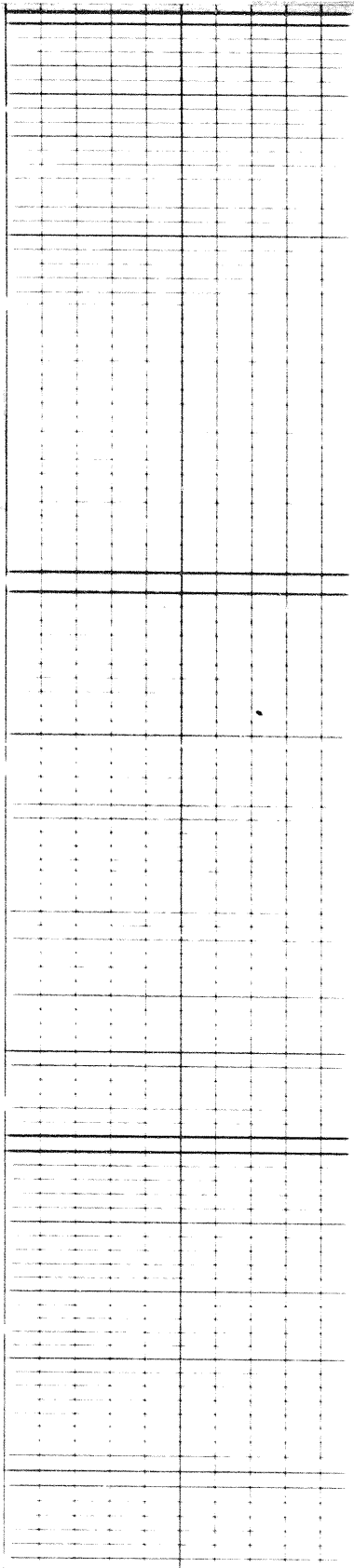

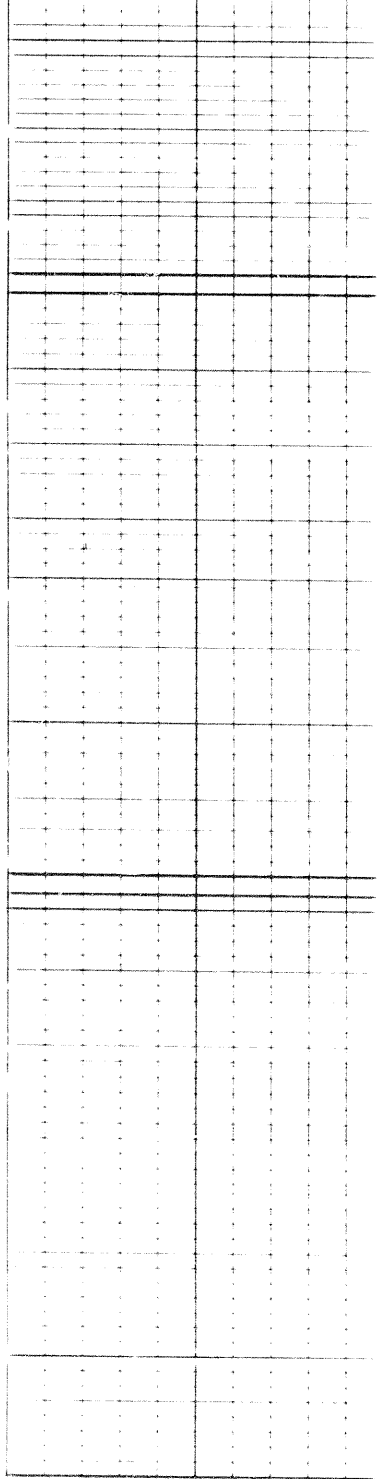

2500

80

85

START 0238 / 15  
STOP 0241 / 15

90

3000

80

85

TOOL THEN HUNG UP @ 3278\*

START 0253 / 15  
STOP 0256 / 15

90

START LOGGING DOWN 0814 / 16 RUN #2  
FIRST READING 6435\*

45

50

55

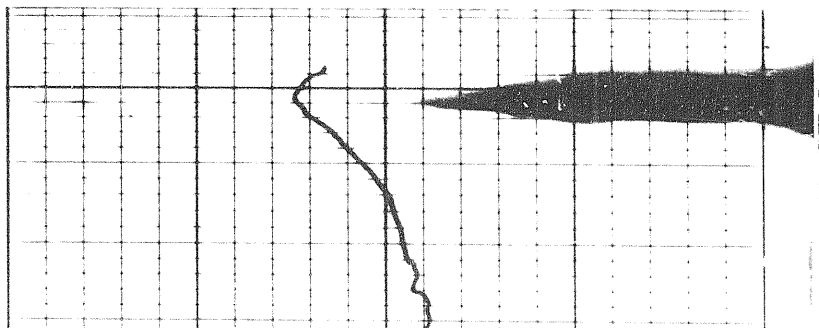
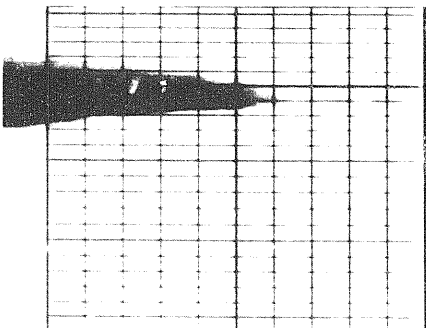

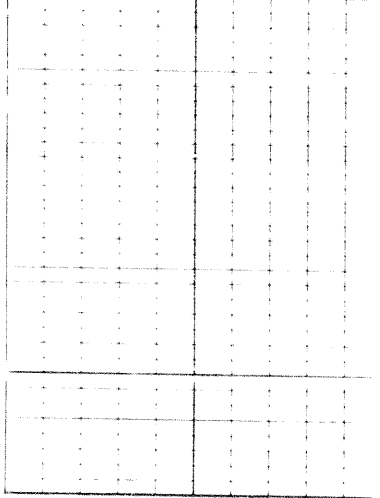

3000

80

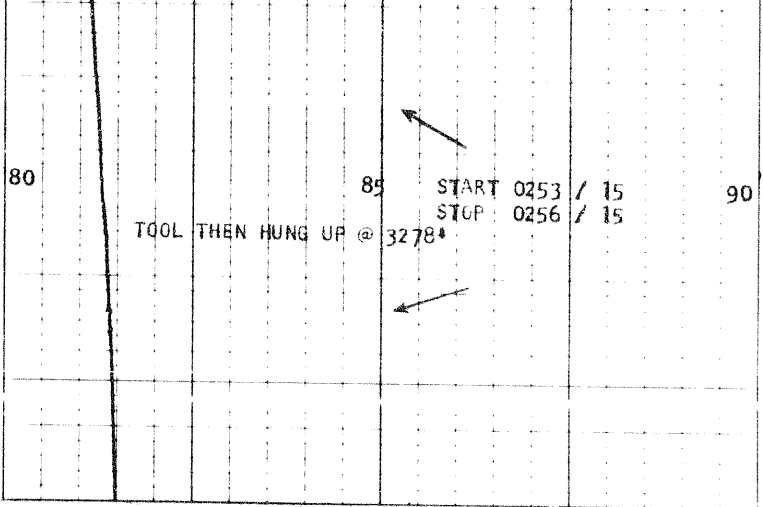

85

START 0253 / 15  
STOP 0256 / 15

90

TOOL THEN HUNG UP @ 3278'

START LOGGING DOWN 0814 / 16 RUN #2  
FIRST READING 6435'

45

50

55

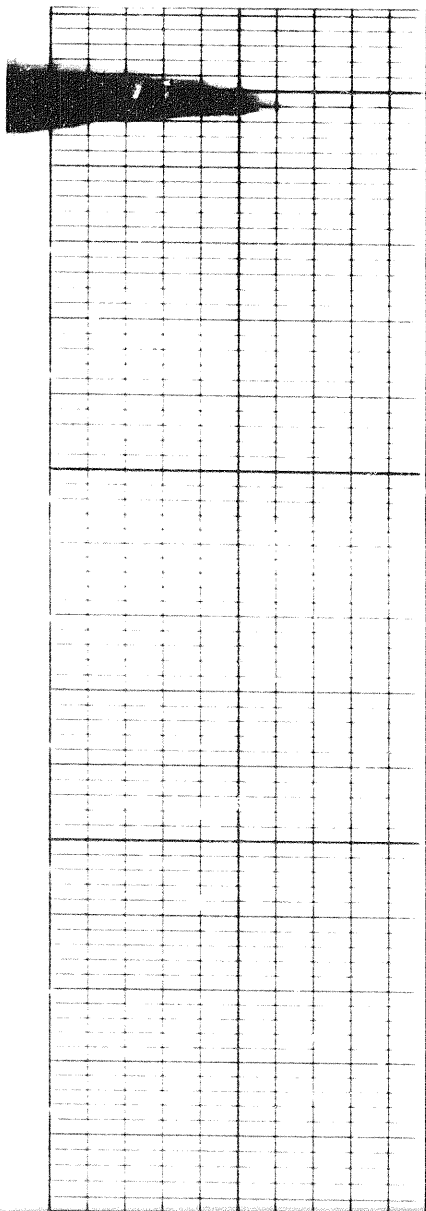

100

200

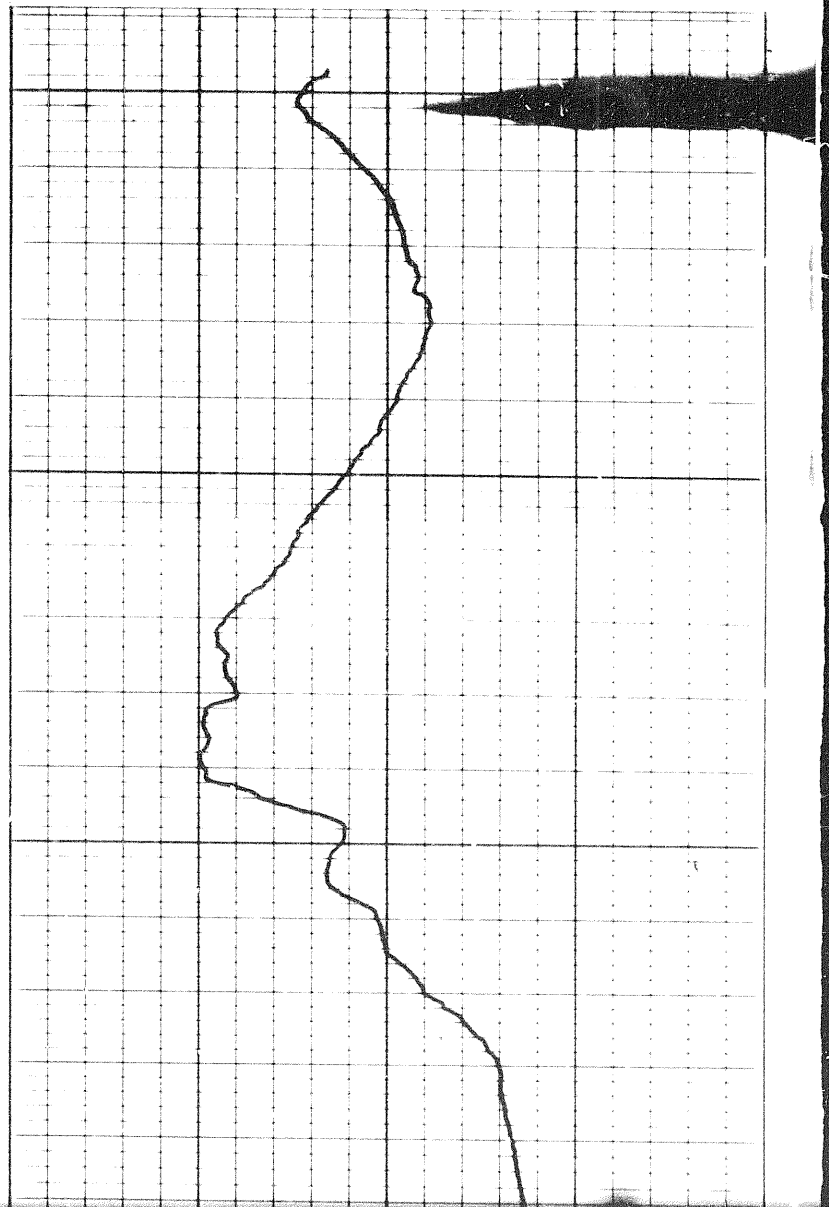

5 of

200

300

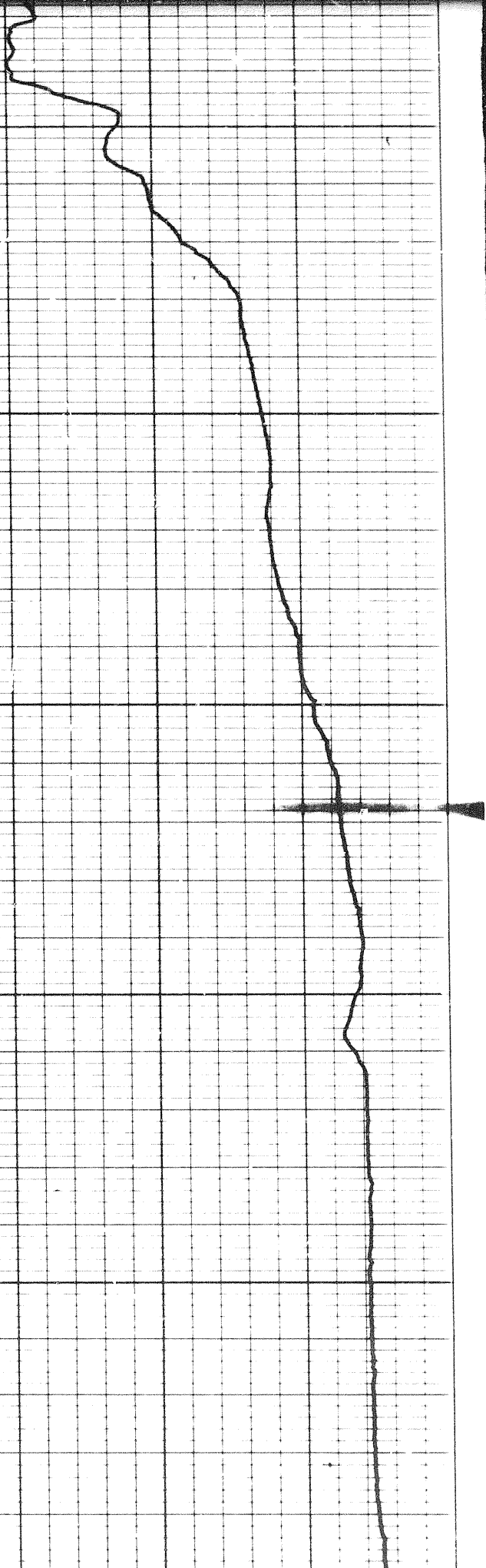



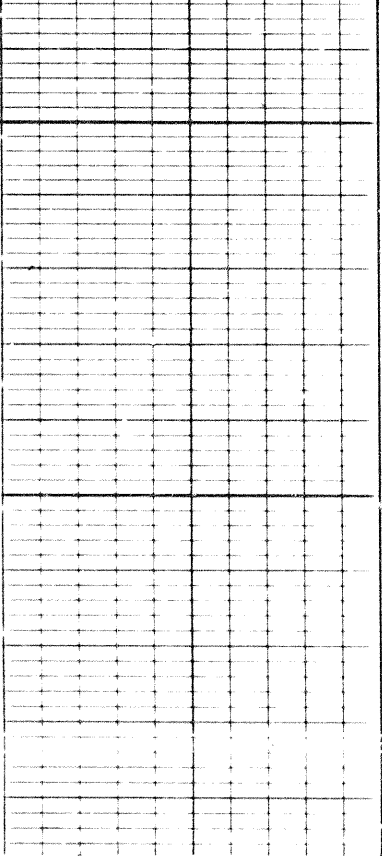

400

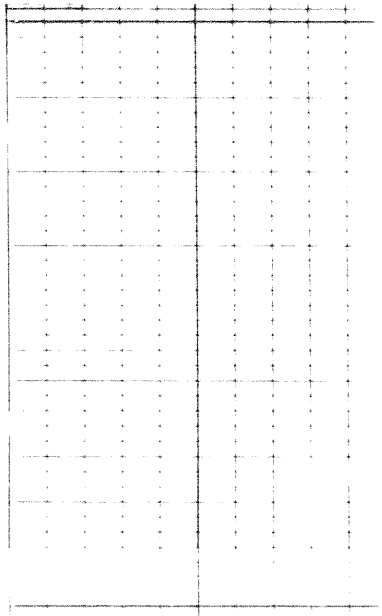
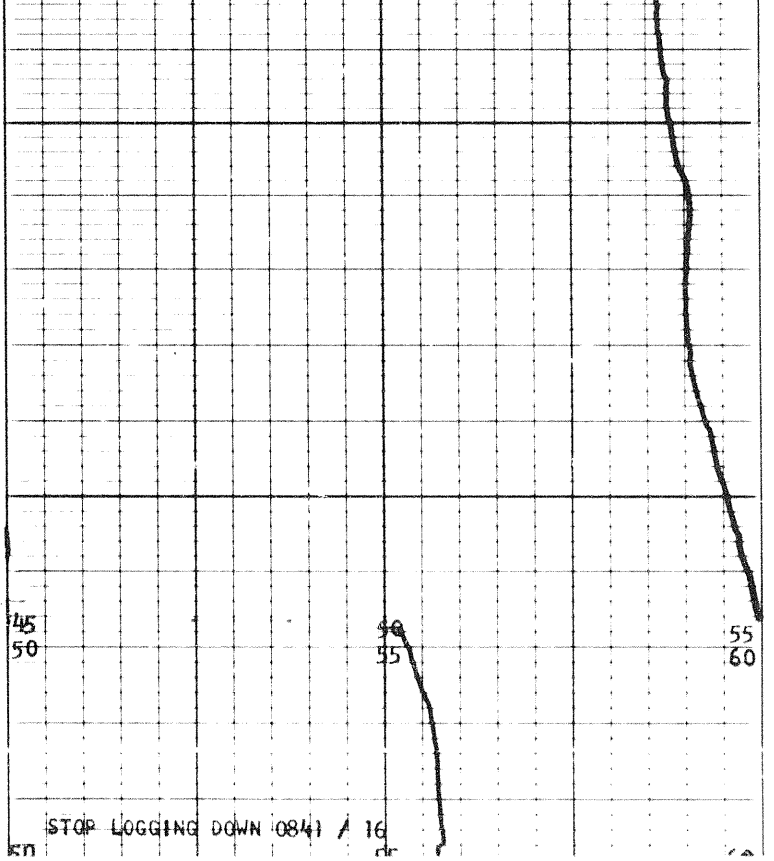

1600

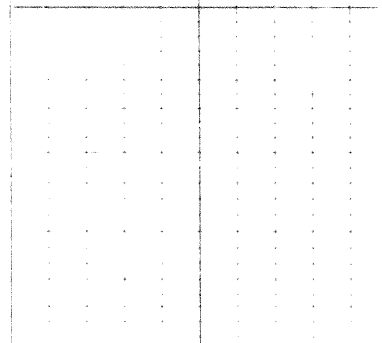
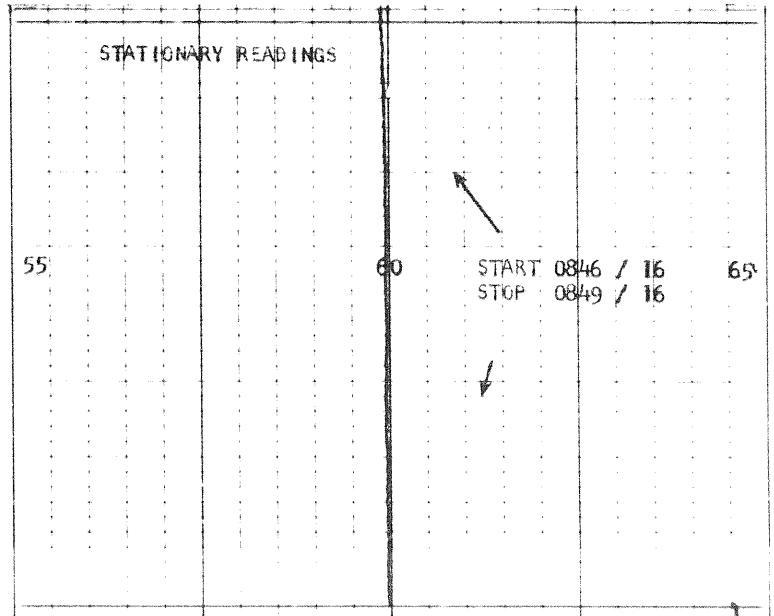

1500

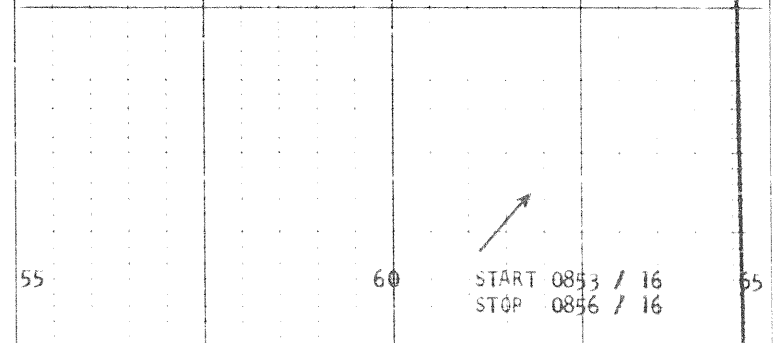

1500 55

60

START 0853 / 16  
STOP 0856 / 16

65



2000 60

65

START 0859 / 16  
STOP 0902 / 16

70



2500

70

75

START 0908 / 16  
STOP 0911 / 16

80



6 of 9

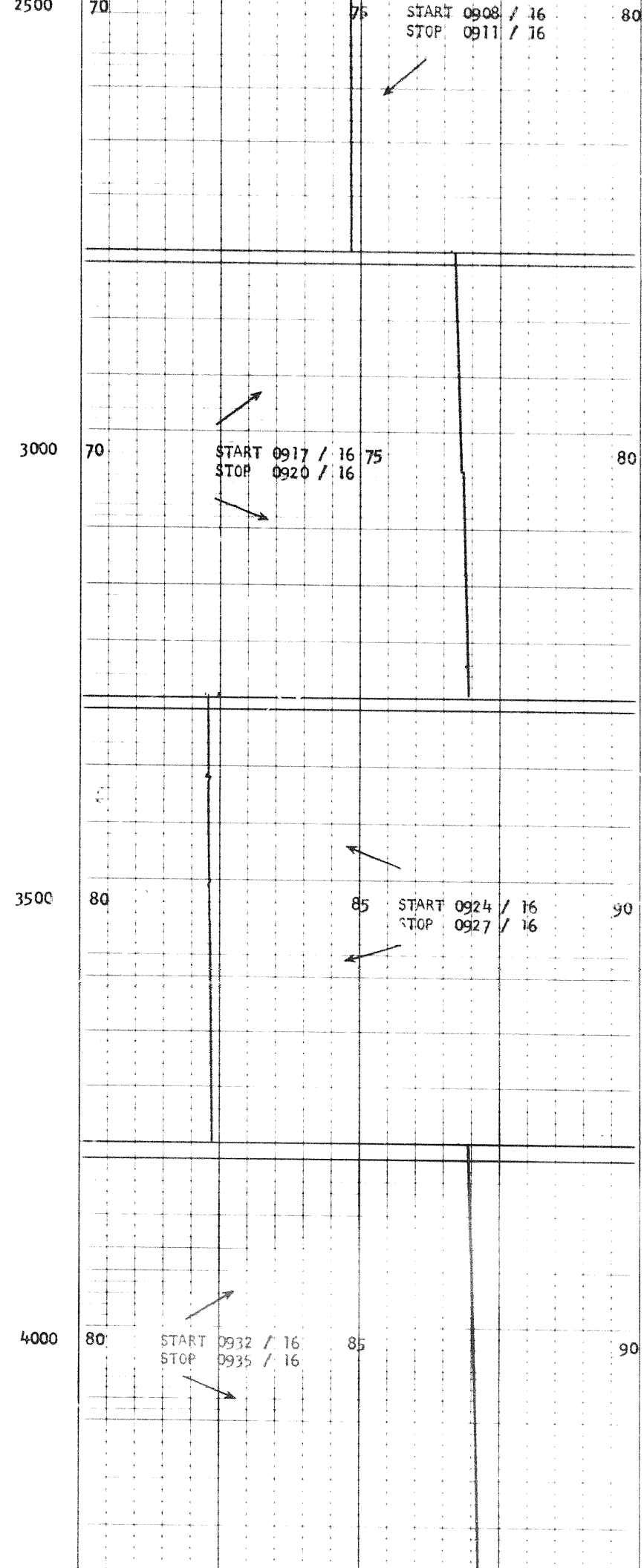

4500

90

95

START 0941 / 16  
STOP 0944 / 16

100

5000

90

95

START 0950 / 16  
STOP 0953 / 16

100

5500

100

105

START 0958 / 16  
STOP 1001 / 16

110

6000

100

105

START 1006 / 16  
STOP 1009 / 16

110



START 1000 / 16  
STOP 1009 / 16

4000

80

START 0932 / 16  
STOP 0935 / 16

85

90

4500

90

START 0941 / 16  
STOP 0944 / 16

100

5000

90

START 0950 / 16  
STOP 0953 / 16

100

7047

5500

100

105

START 0958 / 16  
STOP 1001 / 16

110

6000

100

105

START 1006 / 16  
STOP 1009 / 16

110

6250

110

115

START 1020 / 16  
STOP 1023 / 16

120

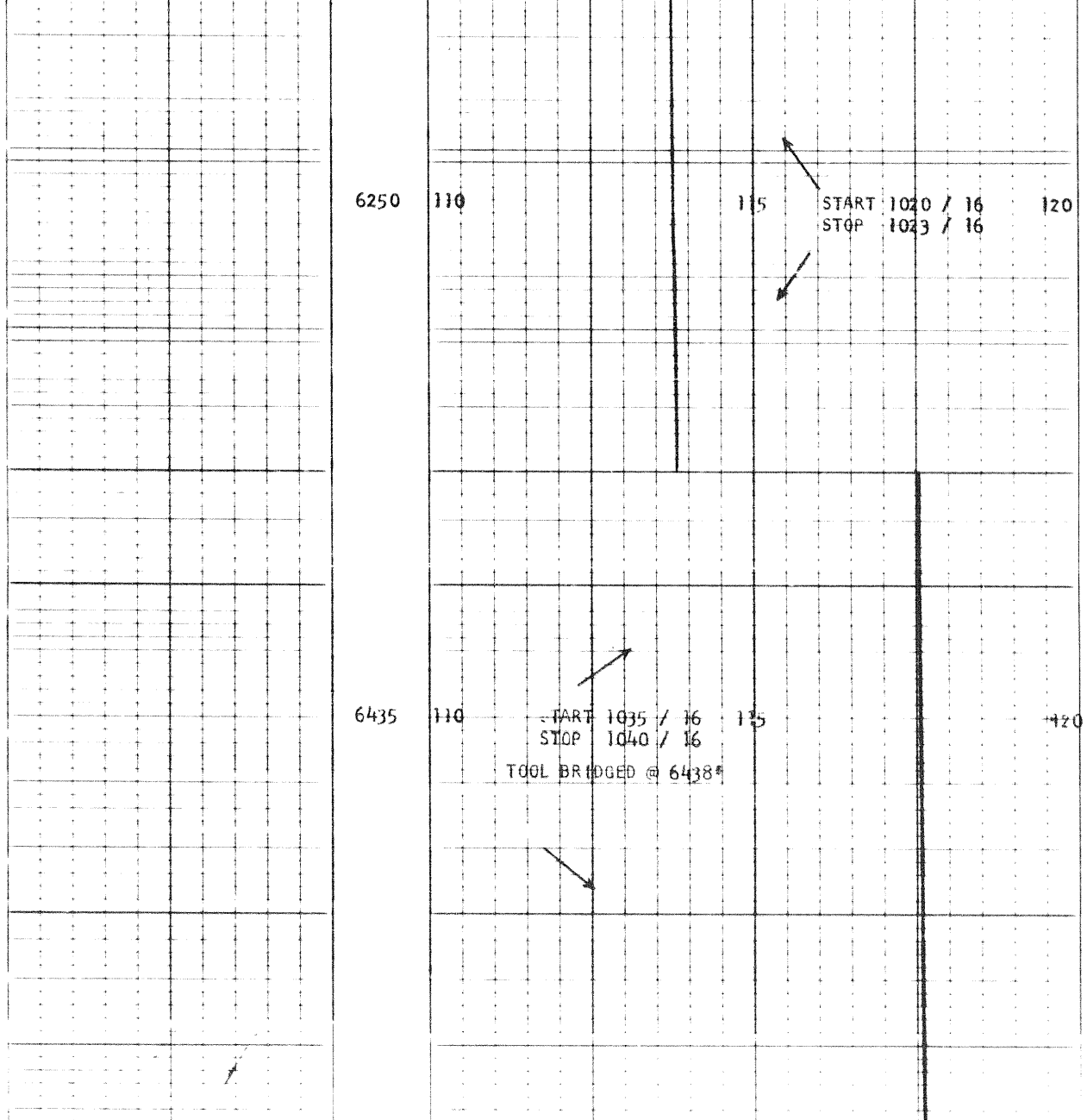

COMPANY	IMPERIAL OIL ENTERPRISES LTD.	
WELL	IOE SPRING RIVER YT N-58	
FIELD	PROVINCE YUKON TERRITORIES	